

ROOF-AM

Torrino Assiale ad Anello - Motore "Unel-Mec" Ring Axial Roof Fans - "Unel-Mec" Motor



APPLICAZIONI

I torrini serie ROOF-AM sono destinati ad impieghi in cui necessitano grandi portate d'aria, in applicazioni a tetto, senza lunghe canalizzazioni. Ad esempio: ventilazione di edifici industriali (stabilimenti, magazzini), allevamenti, sala macchine, ecc.

GAMMA

La serie è costituita da 7 grandezze con diametro girante da 500 a 1000 mm.

PECULIARITÀ

La serie ROOF-AM è caratterizzata dalla presenza di imbocchi ad ampio raggio di curvatura, sia all'ingresso che all'uscita dell'aria, i quali garantiscono massima silenziosità ed elevati rendimenti aerulici, inoltre essi consentono l'efficace utilizzo del torrino come estrattore o come immissore. Il motore è facilmente raggiungibile sia per effettuare il primo collegamento elettrico sia per esigenze di manutenzione. Il motore è costruito seguendo standard internazionali garantendo così affidabilità ed a lungo termine un economico recupero del ventilatore semplicemente riparando o sostituendo il motore stesso.

COSTRUZIONE

- Convogliatore ad anello con doppio bordo ad ampio raggio di curvatura e base d'ancoraggio in lamiera d'acciaio, protetta contro gli agenti atmosferici.
- Cappello in tecnopolimero resistente agli agenti atmosferici.
- Rete antivoltale ed antinfortunistica esterna, realizzata a norme UNI EN 294 in filo d'acciaio e protetta contro gli agenti atmosferici.
- Rete di protezione interna (in assenza di serranda o canalizzazione)
- Girante ad alto rendimento con pale a profilo alare, ad angolo di calettamento variabile da fermo. Mozzo in fusione d'alluminio. Equilibratura secondo norme UNI ISO 1940.
- Motore elettrico asincrono a corrente alternata, protezione IP 55, isolamento CI F, rendimento EFF2, servizio S1, costruzione conforme alle specifiche norme IEC/EEC (UNEL-MEC).
- Esecuzione 4 (accoppiamento diretto con girante a sbalzo).

SPECIFICHE TECNICHE

ROOF-AM standard

- Aria convogliata: pulita o leggermente polverosa, non abrasiva.
- Temperatura aria convogliata: -20°C / +50°C
- Tensione d'alimentazione: versione trifase (T) 400V-3Ph versione monofase (M) 230V-1Ph
- Frequenza: 50Hz.
- Funzionamento in estrazione.

ACCESSORI

- Serranda a gravità, solo in estrazione (GS-RO).
- Interruttore di servizio.
- Morsettiera esterna (OTB).
- Basi d'appoggio su coperture ondulate (SB).
- Silenziatore (SIL-RO).
- Controbase a murare (CB).
- Rete lato girante (PG) obbligatoria nell'utilizzo a bocca libera.

A RICHIESTA

- Versioni per funzionamento in immissione.
- Versioni con flusso dell'aria "effettivamente" reversibile (ROOF-REV).
- Versioni con motore elettrico a doppia polarità.
- Versioni con convogliatore e base in acciaio inossidabile o alluminio.
- Versioni ATEX (Roof-AM ATEX)

APPLICATIONS

The fans of the ROOF-AM series are designed to extract large volumes of air in roof installations, without long ducts. For instance: ventilation of industrial buildings (factories, warehouses etc.) of stock farms and electrical equipments etc.

RANGE

The series is composed by 7 sizes with impeller from 500 up to 1000 mm.

ADVANTAGES

The ROOF-AM fans are characterized from the presence of wide round shaped nozzles in both the inlet and the outlet of the casing, warranting reduced noise level and high efficiency, besides they allow the effective use of the roof fan either to exhaust or supply duty. The electric motor is easily accessible for the electric wiring and maintenance. The motor is manufactured according to international standards assuring reliability and, long-term, an economic recovery of the fan simply repairing or replacing the motor itself.

CONSTRUCTION

- Ring casing, with double wide round shaped nozzle, and base of fixing resistant to atmospheric agents.
- Upper cover in techno-polymer resistant to the atmospheric agents.
- Protection grid on outlet side in steel rod, manufactured according to UNI 9219.
- Inside protection grid (in lack of shutter or ducts).
- Impeller with high efficiency airfoil blades. Hub in die-cast aluminium. Balancing according to UNI ISO 1940. Variable pitch angle in still position.
- Asynchronous electric motor, protection IP 55, Class F insulated, output EFF2, service S1, construction according to IEC / EEC (UNEL-MEC) standard.
- Execution 4 (impeller directly coupled to motor shaft).

TECHNICAL SPECIFICATIONS

ROOF-AM standard

- Conveyed air: clean, not abrasive.
- Temperature of conveyed air: -20°C / +50°C.
- Voltage: three phase version (T) 400V-3Ph. single phase version (M) 230V-1Ph.
- Frequency: 50Hz.
- Working as exhaust fan.

ACCESSORIES

- Inlet gravity shutter, only for exhaust fans (GS-RO).
- Service switch.
- Outer terminal box (OTB).
- Support base for corrugate roof covering (SB).
- Silencer (SIL-RO).
- Counter base (CB).
- Inlet grid (PG) mandatory for free air.

UPON REQUEST

- Intake versions.
- Versions with air flow true reversible (ROOF-REV).
- Versions with three phase two polarity electric motor.
- Versions with casing and base in stainless steel or aluminium.
- Explosion proof versions (Roof-AM ATEX)

4 poli/poles (1500 rpm) - trifase/three-phases (3Ph-400V 50Hz)

Modello Model	Portata - Flow rate (m ³ /h)	Pm (kW)	In max (A)	Mot. (H)	Lp dB(A)
504 T	7.200	0,55	1,6	80	60
564 T	10.500	0,75	2	80	61
634 T	14.000	1,1	2,8	90S	66

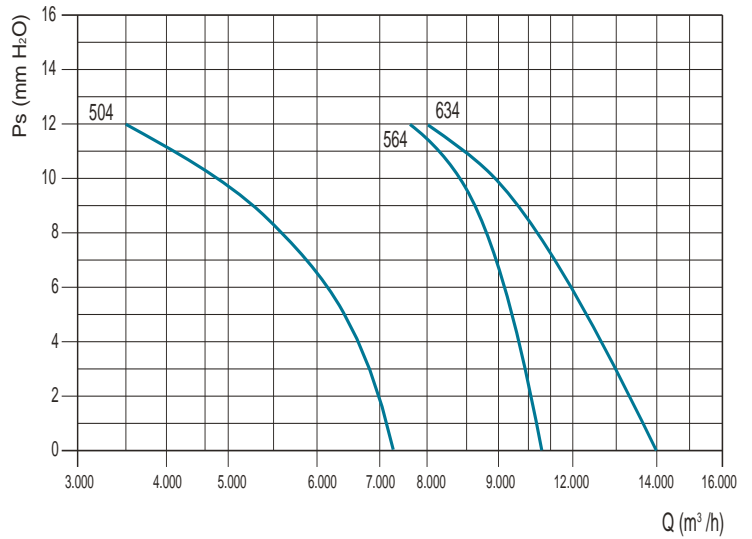

6 poli/poles (1000 rpm) - trifase/three-phases (3Ph-400V 50Hz)

Modello Model	Portata - Flow rate (m ³ /h)	Pm (kW)	In max (A)	Mot. (H)	Lp dB(A)
636A T	9.500	0,37	1,3	80	57
636B T	10.500	0,55	1,8	80	59
716A T	12.500	0,75	2,2	90S	59
716B T	16.000	1,1	3	90	61
806 T	20.000	1,5	4	100	62
906 T	25.000	1,5	4	100	63
1006 T	30.000	2,2	5	112	66

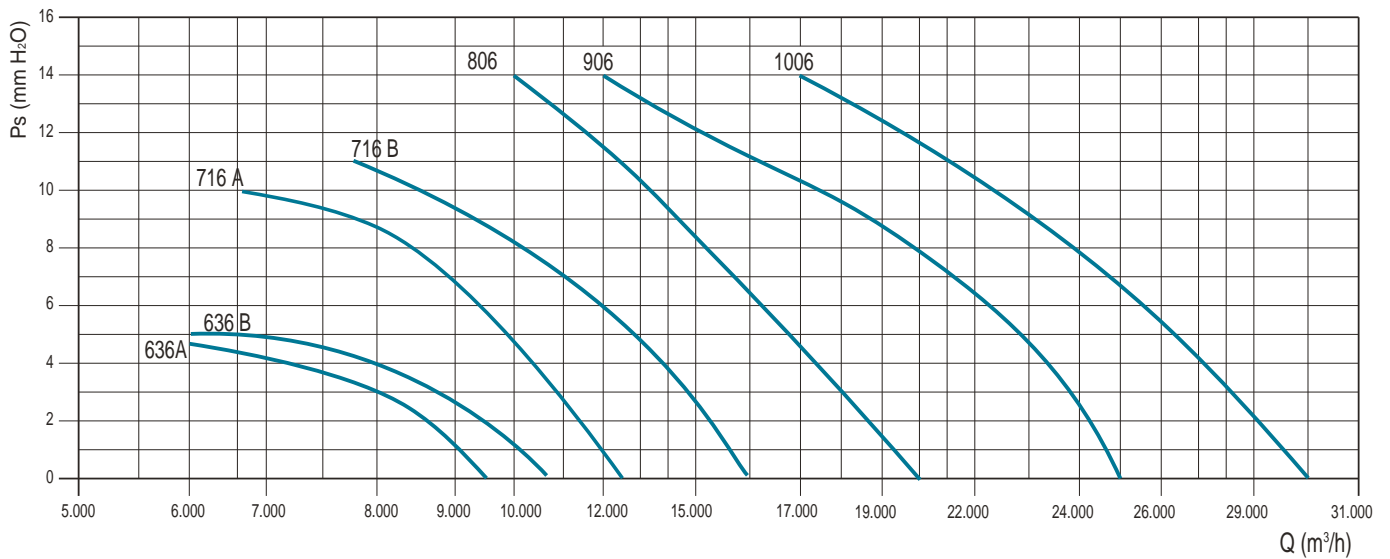

8 poli/poles (750 rpm) - trifase/three-phases (3Ph-400V 50Hz)

Modello Model	Portata - Flow rate (m ³ /h)	Pm (kW)	In max (A)	Mot. (H)	Lp dB(A)
808A T	15.000	0,55	2	90L	55
808B T	16.500	0,75	2,3	100	57
908A T	18.800	0,75	2,3	100	57
908B T	21.000	1,1	3,4	100L	60
1008A T	22.500	1,1	3,4	100L	60
1008B T	26.000	1,5	4	112	65

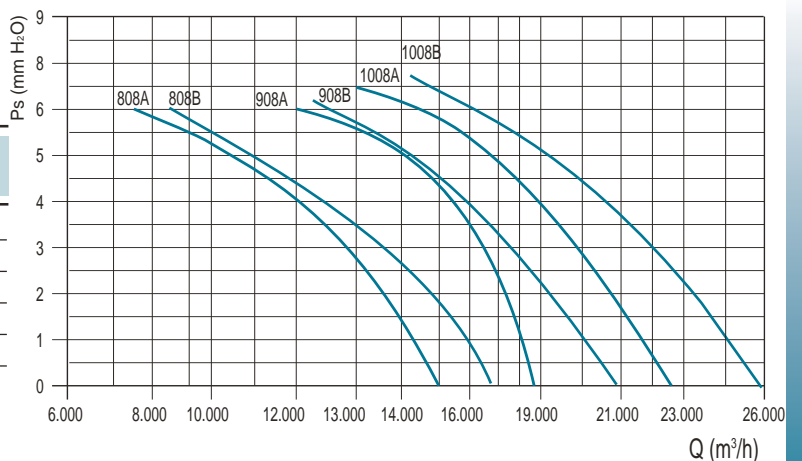

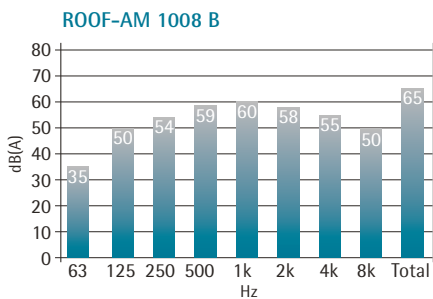
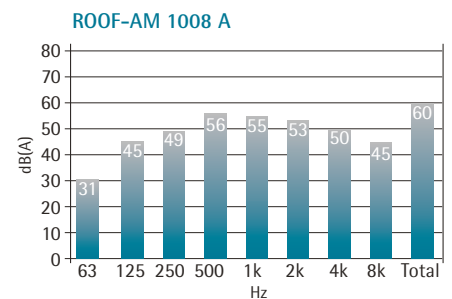
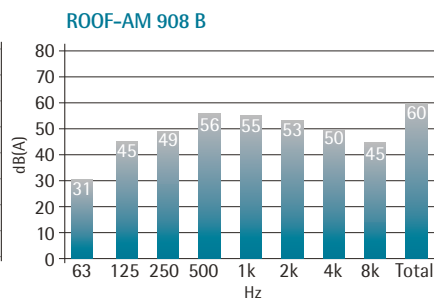
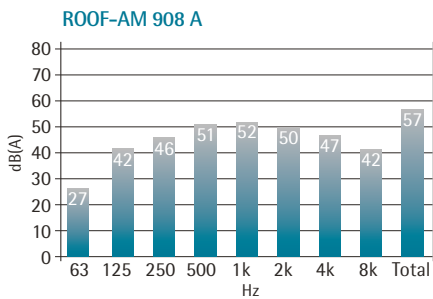
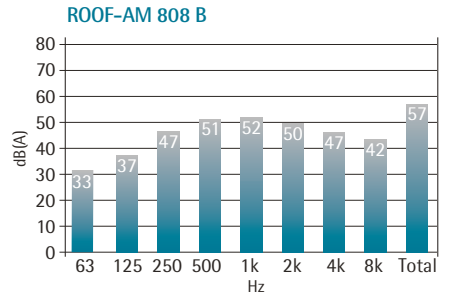
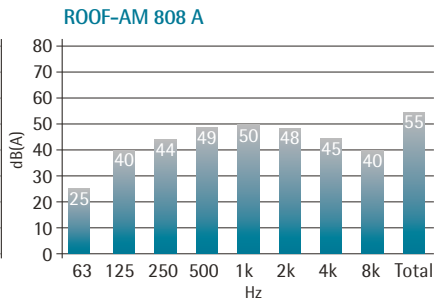
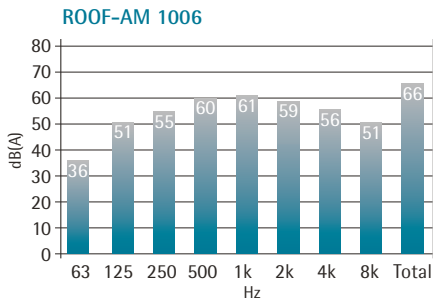
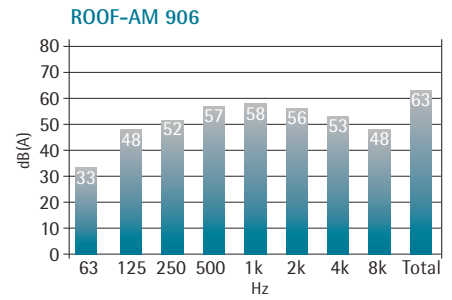
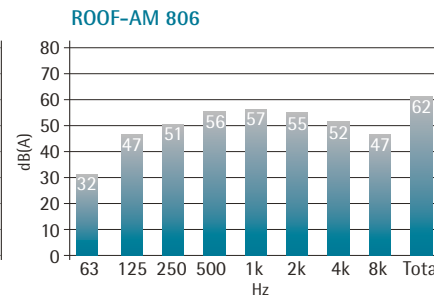
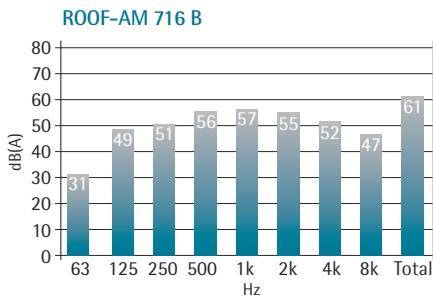
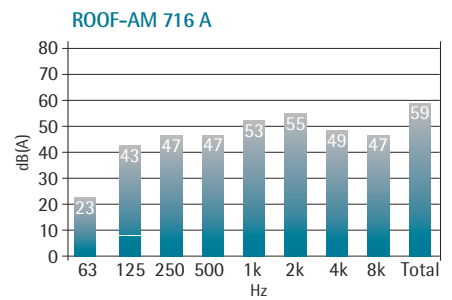
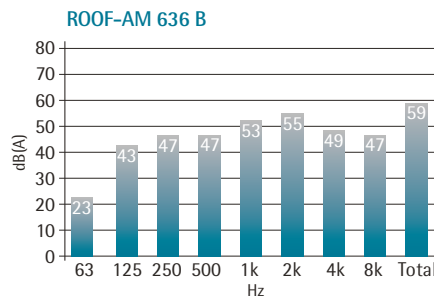
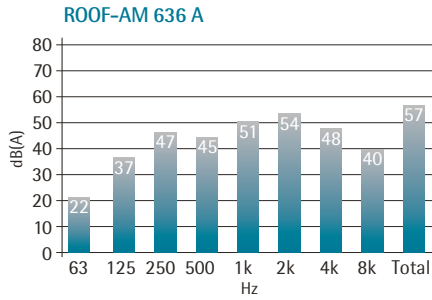
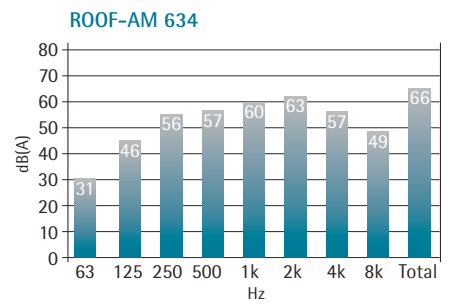
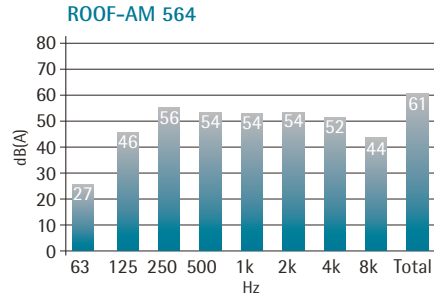
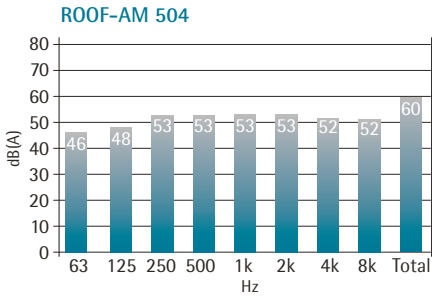

Attenzione: il livello di pressione sonora è riferito ad una misurazione onnidirezionale in campo libero a 6 metri dal ventilatore con aspirazione e mandata libera.
 Attention: the sound pressure level is measured in free field at 6 meter from the fan, in any direction, with free inlet and outlet

Model	ØA	BxB	CxC	ØD	E	ØF	kg*
50	510	760	710	1000	450	10	38
56	570	760	710	1000	450	10	42
63	640	930	870	1200	500	10	58
71	710	930	870	1200	500	10	67
80	815	1150	1050	1600	650	12	85
90	915	1300	1200	1600	650	12	110
100	1015	1300	1200	1600	700	12	140

Dimensioni in mm/Dimensions in mm
 (*) Indicativo/Indicative

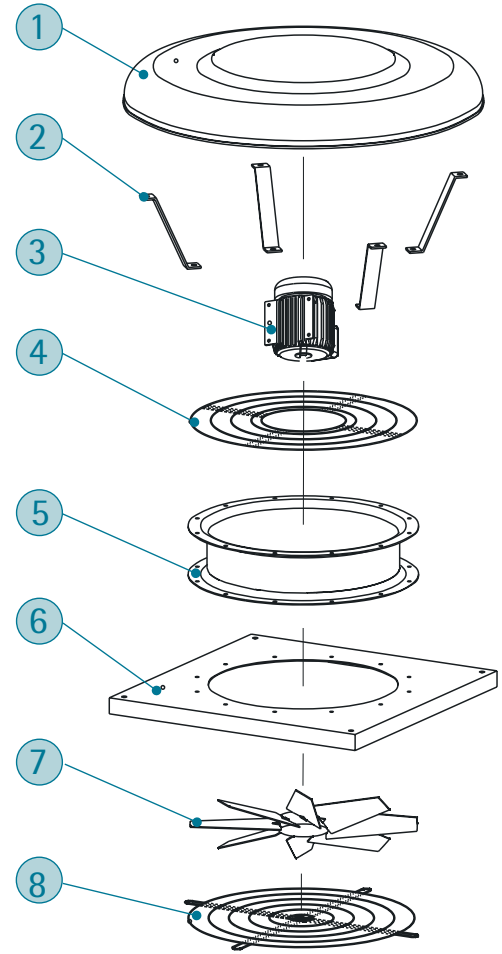
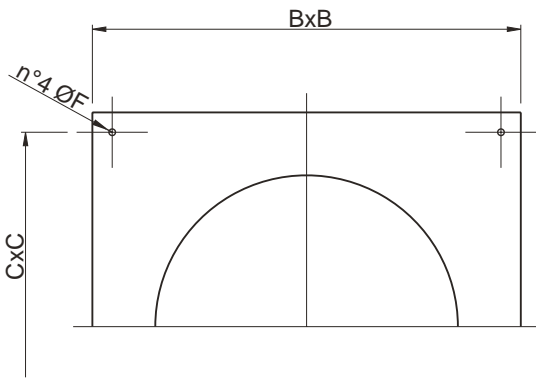
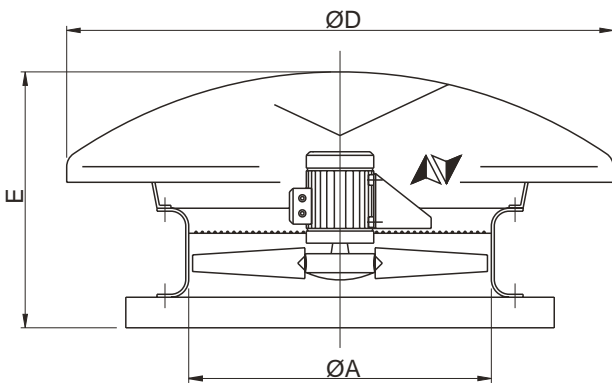

- 1 - Cappello/Cover
- 2 - Staffe/Brackets
- 3 - Motore/Motor
- 4 - Rete/Grid
- 5 - Convogliatore/Ring casing
- 6 - Base/Base frame
- 7 - Girante/Impeller
- 8 - Rete (accessorio)
 obbligatorio per marcature "CE" in
 assenza di serranda o canalizzazione
 Grid (accessory) mandatory to have "CE"
 mark without shutter or ducts

SERRANDE A GRAVITÀ (GS-RO)

Le alette della serranda di gravità si aprono con il movimento dell'aria a ventilatore acceso e si richiudono per gravità al suo spegnimento evitando dispersioni di calore.

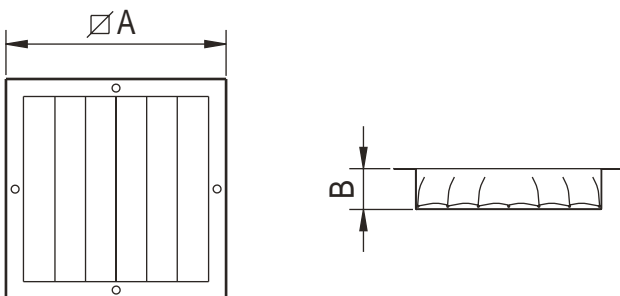

GRAVITY SHUTTERS (GS-RO)

The blades of the shutter are opened by the airflow when the fan starts and they shut by gravity when the fan stops, thus avoiding heat waste.

Model	A	B	kg
50-56	690	150	9
63-71	805	150	10
80	990	150	13
90-100	1160	150	15

Dimensioni in mm/Dimensions in mm
 (*) Indicativo/Indicative

SBm SBI SBc

Basi d'appoggio ondulate per torrini Support bases for roof fans

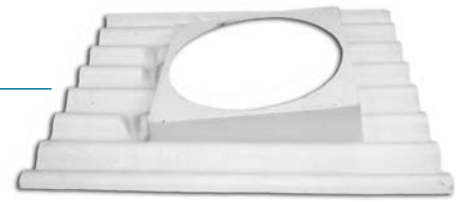

SBm SBI



SBc

APPLICAZIONI

Le basi d'appoggio ondulate SB (converse) realizzate in robusta vetro-resina, sono adatte per l'installazione dei nostri torrini su coperture costruite in lastre ondulate, evitando dannosi ristagni d'acqua attorno al ventilatore e costose opere murarie o di carpenteria.

APPLICATIONS

The support bases SB (valleys), manufactured in sturdy glass-resin, are suitable for the installation of our roof fans on overlays built in corrugated slabs, avoiding detrimental stagnations of water nearby the fan and costly masonry or carpentry works.

VERSIONI

Esistono tre tipologie:
SBm: utilizzabile con torrini aventi basamento 760x760 mm (Modelli 50 e 56).
SBI: utilizzabile con torrini aventi basamento 930x930 mm (Modelli 63 e 71).
SBc: utilizzabile con torrini aventi basamento 930x930 mm (Modelli 63 e 71).

VERSIONS

Three types are available:
SBm: to be used with roof fans having bases 760x760 mm (Models 50 and 56)
SBI: to be used with roof fans having bases 930x930 mm (Models 63 and 71)
SBc: to be used with roof fans having bases 930x930 mm (Models 63 and 71)

Le versioni SBI e SBm possono essere accoppiate a lastre ondulate con pendenza falda tipo "Euro" (passo 177 mm altezza 51mm) o tipo internazionale (passo 146 mm altezza 48 mm)

Both versions SBI and SBm are suitable to be coupled to corrugated slabs with pitch slope Euro type (pitch 177 mm height 51mm) or International type (pitch 146 mm height 48 mm).

La versione SBc può essere accoppiata a lastre ondulate con lastre tipo "Euro" (passo 177 mm altezza 51mm) e raggio di curvatura lastra pari a 3 metri.

SBc version shall be coupled to corrugated slabs with pitch slope "Euro" type (pitch 177 mm height 51 mm) and radius of curvature of the sheet of 3 meters.

INSTALLAZIONE

Sovrapporre la conversa alla lastra a valle e sottoposizionarla a monte. Sovrapporsi di almeno un'onda e un quarto con le lastre laterali attigue. Verificare di non avere sovraccaricato eccessivamente la conversa.

INSTALLATION

Overlap the valley to the slab downstream and under-place it upstream. Overlap not less than one and fourth wave with the lateral adjacent slabs. Verify not to have excessively overloaded the valley.

SBm

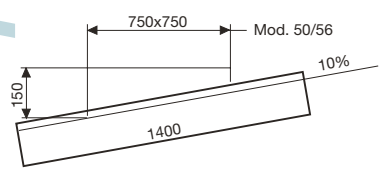

SBI

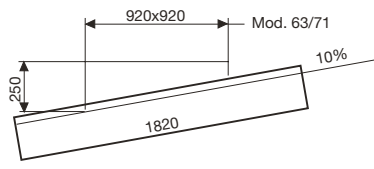

SBc

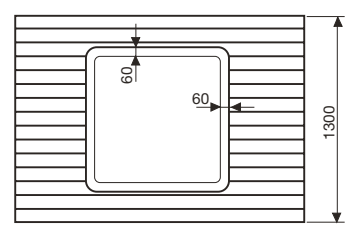
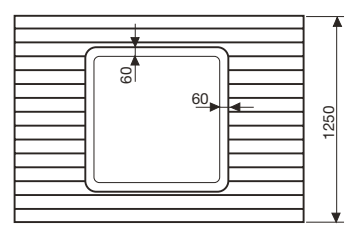
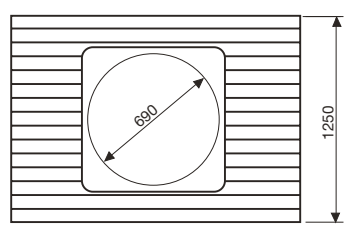
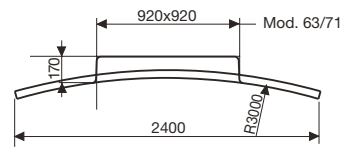

SBm/1

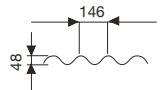

SBm/2

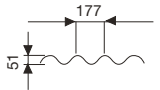

SBI/1

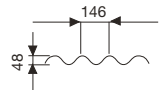

SBI/2

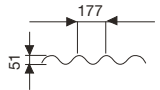

SBc

